

# Parallel Persistent SRAM Memory

(AS3001308, AS3004308, AS3008308, AS3016308, AS3032308)

## Features

- Interface
  - Parallel Asynchronous x8
- Technology
  - 40nm pMTJ STT-MRAM
  - Virtually unlimited Endurance and Data Retention (see Endurance and Data Retention on page 21)
- Density
  - 1Mb, 4Mb, 8Mb, 16Mb, 32Mb
- Operating Voltage Range
  - $V_{CC}$ : 2.70V – 3.60V
- Operating Temperature Range
  - Industrial: -40°C to 85°C
  - Industrial Plus: -40°C to 105°C
- RoHS Compliant
- Packages
  - 44-pin TSOP (10mm x 18mm)
  - 48-ball FBGA (10mm x 10mm)
- Memory Array Organization
  - 1Mbit
    - 131,072 x 8
  - 4Mbit
    - 524,288 x 8
  - 8Mbit
    - 1,048,576 x 8
  - 16Mbit
    - 2,097,152 x 8
  - 32Mbit
    - 4,194,304 x 8

## Performance

Device Operation	Typical Values	Units
<b>Read Cycle Time</b>	35.0 (minimum)	ns
<b>Write Cycle Time</b>	35.0 (minimum)	ns
<b>Standby Current</b>	1.7 (typical)*	mA
<b>Sleep Mode Current</b>	5.0 (typical)*	uA
<b>Read Current</b>	20.0 (typical)	mA
<b>Write Current</b>	20.0 (typical)	mA

\*Number shown is for 16Mb device

## Table of Contents

<b>Features</b> .....	1
<b>Performance</b> .....	1
<b>Table of Contents</b> .....	2
<b>General Description</b> .....	3
<b>Ordering Options</b> .....	4
<b>Valid Combinations — Standard</b> .....	4
<b>Signal Description and Assignment</b> .....	7
<b>Package Options</b> .....	8
<b>44-Pin TSOP (Top View)</b> .....	8
<b>48-Ball FBGA (Balls Down, Top View)</b> .....	8
<b>Package Drawings</b> .....	9
<b>44-Pin TSOP</b> .....	9
<b>48-Ball FBGA</b> .....	10
<b>Architecture</b> .....	11
<b>Device Initialization</b> .....	12
<b>Electrical Specifications</b> .....	15
<b>Write Operation</b> .....	17
<b>Bus Turnaround Operation – Read to Write</b> .....	19
<b>Read Operation</b> .....	20
<b>Endurance and Data Retention</b> .....	21
<b>Thermal Resistance</b> .....	22
<b>Product Use Limitations</b> .....	23
<b>Limited Warranty</b> .....	23

## General Description

AS3xxx308 is a magneto-resistive random-access memory (MRAM). It is offered in density ranging from 1Mbit to 32Mbit. MRAM technology is analogous to Flash technology with SRAM compatible 35ns/35ns read/write timings (Persistent SRAM, P-SRAM). Data is always non-volatile. This makes MRAM a very reliable and fast non-volatile memory solution.

**Table 1: Technology Comparison**

	SRAM	Flash	EEPROM	MRAM
<b>Non-Volatility</b>	–	√	√	√
<b>Write Performance</b>	√	–	–	√
<b>Read Performance</b>	√	–	–	√
<b>Endurance</b>	√	–	–	√
<b>Power</b>	–	–	–	√

MRAM is a true random-access memory; allowing both reads and writes to occur randomly in memory. MRAM is ideal for applications that must store and retrieve data without incurring large latency penalties. It offers low latency, low power, virtually unlimited endurance and data retention, high performance and scalable memory technology.

AS3xxx308 is available in small footprint 44-pin TSOP (10mm x 18mm) and 48-ball FBGA (10mm x 10mm) packages. Densities ranging from 1Mb to 16Mb are available on the 44-pin TSOP package. Densities ranging from 1Mb to 32Mb are available on the 48-ball FBGA package. These packages are compatible with similar low-power volatile and non-volatile products.

AS3xxx308 is offered with industrial (-40°C to 85°C) and industrial plus (-40°C to 105°C) operating temperature ranges.

## Ordering Options

The ordering part numbers are formed by a valid combination of the following options:

*Figure 1: Part Number Ordering System*

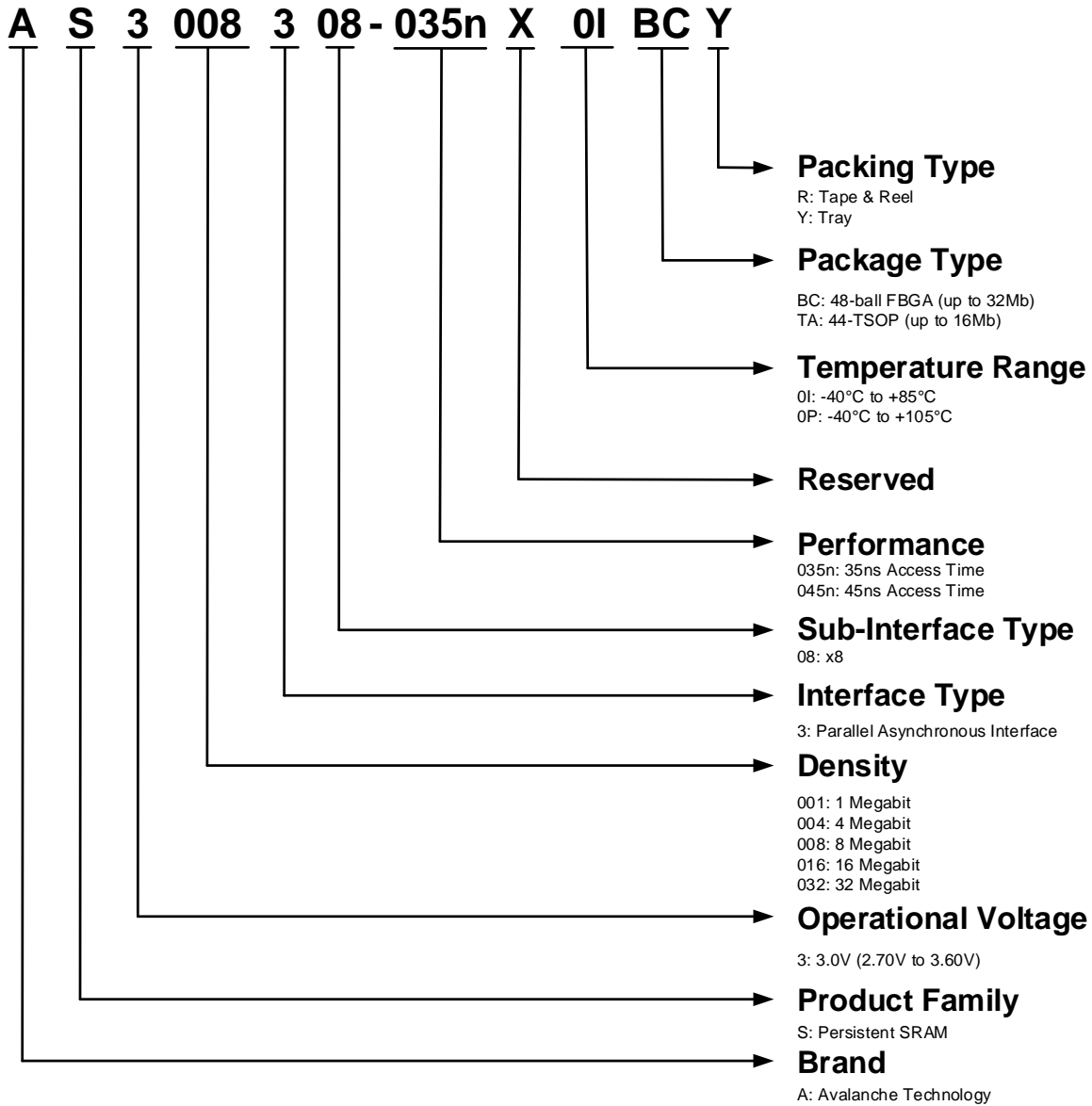

### Valid Combinations — Standard

Valid Combinations list includes device configurations currently available. Contact your local sales office to confirm availability of specific valid combinations and to check on newly released combinations.

**Table 2: Valid Combinations List**

Valid Combinations – 35ns				
Base Part Number	Temperature Range	Package Type	Packing Type	Part Number
AS3001308-035nX	0I, 0P	BC, TA	R, Y	AS3001308-035nX0IBCR
				AS3001308-035nX0IBCY
				AS3001308-035nX0ITAR
				AS3001308-035nX0ITAY
				AS3001308-035nX0PBCR
				AS3001308-035nX0IBCY
				AS3001308-035nX0PTAR
				AS3001308-035nX0PTAY
AS3004308-035nX	0I, 0P	BC, TA	R, Y	AS3004308-035nX0IBCR
				AS3004308-035nX0IBCY
				AS3004308-035nX0ITAR
				AS3004308-035nX0ITAY
				AS3004308-035nX0PBCR
				AS3004308-035nX0PBCY
				AS3004308-035nX0PTAR
				AS3004308-035nX0PTAY
AS3008308-035nX	0I, 0P	BC, TA	R, Y	AS3008308-035nX0IBCR
				AS3008308-035nX0IBCY
				AS3008308-035nX0ITAR
				AS3008308-035nX0ITAY
				AS3008308-035nX0PBCR
				AS3008308-035nX0PBCY
				AS3008308-035nX0PTAR
				AS3008308-035nX0PTAY
AS3016308-035nX	0I, 0P	BC, TA	R, Y	AS3016308-035nX0IBCR
				AS3016308-035nX0IBCY
				AS3016308-035nX0ITAR
				AS3016308-035nX0ITAY
				AS3016308-035nX0PBCR
				AS3016308-035nX0PBCY
				AS3016308-035nX0PTAR
				AS3016308-035nX0PTAY
AS3032308-035nX	0I, 0P	BC	R, Y	AS3032308-035nX0IBCR
				AS3032308-035nX0IBCY
				AS3032308-035nX0PBCR
				AS3032308-035nX0PBCY

Valid Combinations – 45ns				
Base Part Number	Temperature Range	Package Type	Packing Type	Part Number
AS3001308-045nX	0I, 0P	BC, TA	R, Y	AS3001308-045nX0IBCR
				AS3001308-045nX0IBCY
				AS3001308-045nX0ITAR
				AS3001308-045nX0ITAY
				AS3001308-045nX0PBCR
				AS3001308-045nX0PBCY
				AS3001308-045nX0PTAR
				AS3001308-045nX0PTAY
AS3004308-045nX	0I, 0P	BC, TA	R, Y	AS3004308-045nX0IBCR
				AS3004308-045nX0IBCY
				AS3004308-045nX0ITAR
				AS3004308-045nX0ITAY
				AS3004308-045nX0PBCR
				AS3004308-045nX0PBCY
				AS3004308-045nX0PTAR
				AS3004308-045nX0PTAY
AS3008308-045nX	0I, 0P	BC, TA	R, Y	AS3008308-045nX0IBCR
				AS3008308-045nX0IBCY
				AS3008308-045nX0ITAR
				AS3008308-045nX0ITAY
				AS3008308-045nX0PBCR
				AS3008308-045nX0PBCR
				AS3008308-045nX0PTAR
				AS3008308-045nX0PTAY
AS3016308-045nX	0I, 0P	BC, TA	R, Y	AS3016308-045nX0IBCR
				AS3016308-045nX0IBCY
				AS3016308-045nX0ITAR
				AS3016308-045nX0ITAY
				AS3016308-045nX0PBCR
				AS3016308-045nX0PBCY
				AS3016308-045nX0PTAR
				AS3016308-045nX0PTAY
AS3032308-045nX	0I, 0P	BC	R, Y	AS3032308-045nX0IBCR
				AS3032308-045nX0IBCY
				AS3032308-045nX0PBCR
				AS3032308-045nX0PBCY

## Signal Description and Assignment

Figure 2: Device Pinout

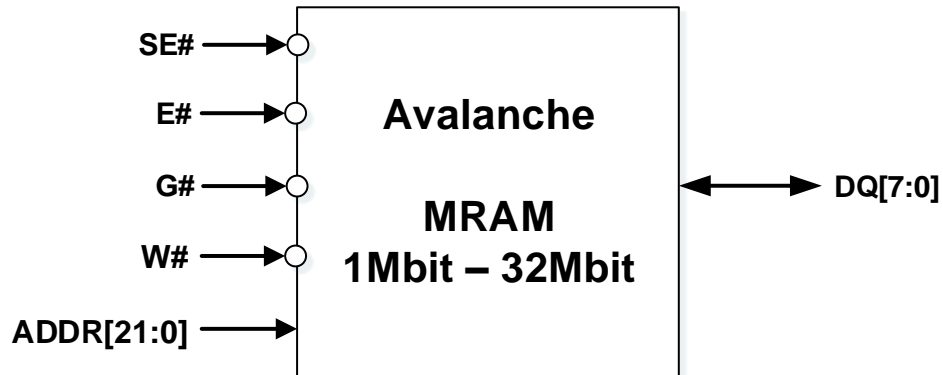
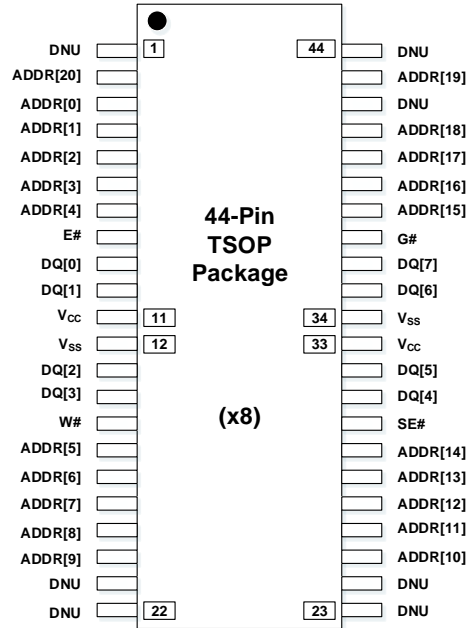

Table 3: Signal Description

Signal	Type	Description
<b>SE#</b>	Input	<b>Sleep:</b> Enables or disables Low power mode. Can be driven or left unconnected.
<b>E#</b>	Input	<b>Chip enable:</b> Enables or disables the MRAM.
<b>G#</b>	Input	<b>Output enable:</b> Enables the output drivers in bidirectional data transfer I/Os.
<b>W#</b>	Input	<b>Write enable:</b> Transfers data from the host system to the MRAM when Low (Logic '0'). Transfers data from the MRAM to the host system when High (Logic '1').
<b>ADDR[21:0]</b>	Input	<b>Address:</b> I/Os for address transfer. 01M: ADDR[16:0] – 17 Address pins for 01M devices. 04M: ADDR[18:0] – 19 Address pins for 04M devices. 08M: ADDR[19:0] – 20 Address pins for 08M devices. 16M: ADDR[20:0] – 21 Address pins for 16M devices. 32M: ADDR[21:0] – 22 Address pins for 32M devices (48-ball FBGA only)
<b>DQ[7:0]</b>	Input / Output	<b>Data inputs/outputs:</b> The bidirectional I/Os transfer data.
<b>V<sub>cc</sub></b>	Supply	<b>V<sub>cc</sub>:</b> Core and I/O power supply.
<b>V<sub>ss</sub></b>	Supply	<b>V<sub>ss</sub>:</b> Core and I/O ground supply.
<b>NC</b>		<b>No connect:</b> NCs are not internally connected. They can be driven or left unconnected.
<b>DNU</b>		<b>Do not use:</b> DNUs must be left unconnected.

## Package Options

### 44-Pin TSOP (Top View)



### 48-Ball FBGA (Balls Down, Top View)

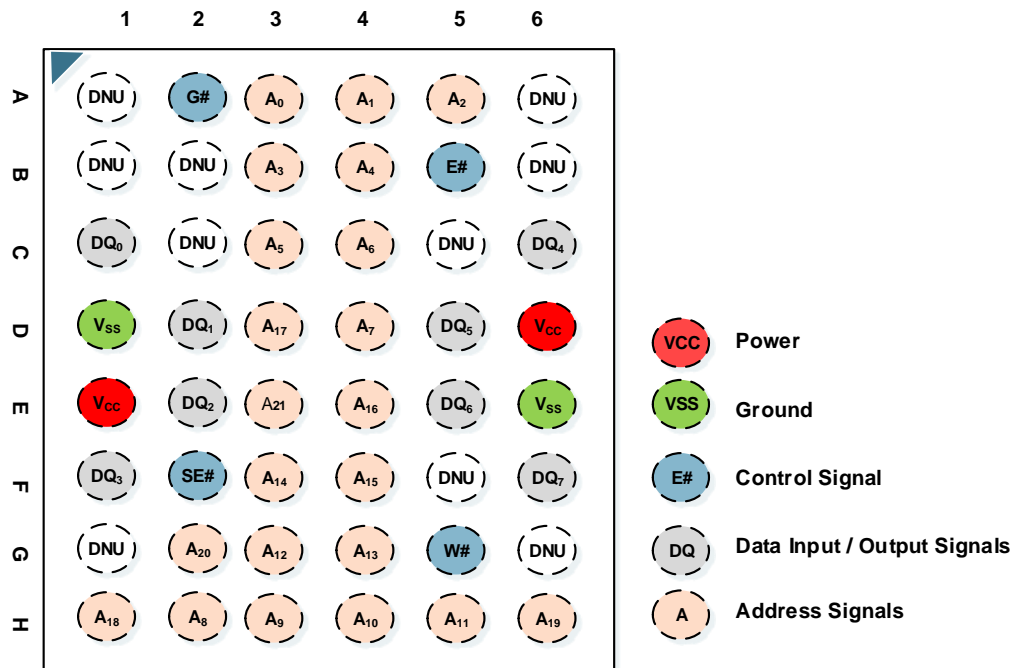



# Package Drawings

## 44-Pin TSOP

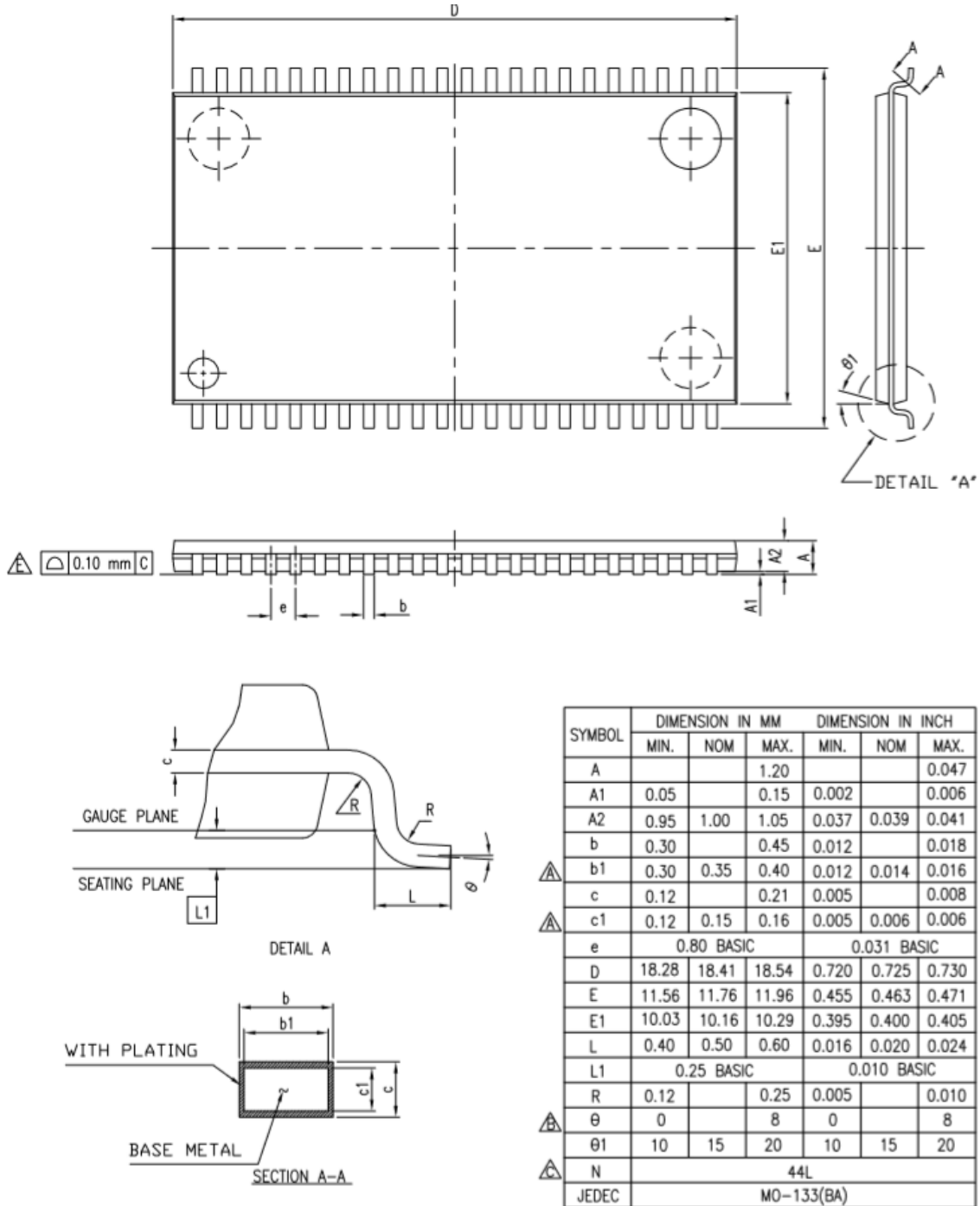

NOTE : DIMENSIONS D AND E1 DO NOT INCLUDE MOLD PROTRUSIONS.  
 D AND E1 ARE MAXIMUM PLASTIC BODY SIZE DIMENSIONS INCLUDING MOLD MISMATCH.

## 48-Ball FBGA

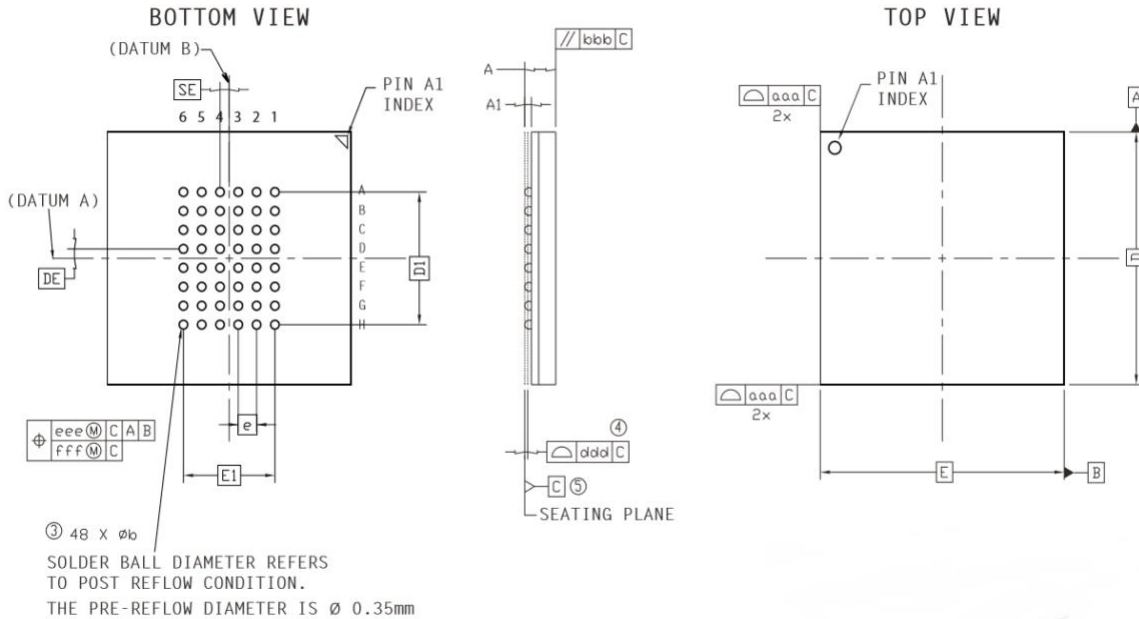

Ref	Min	Nominal	Max
A	1.19	1.27	1.35
A1	0.22	0.27	0.32
b	0.31	0.36	0.41
D	10.00 BSC		
E	10.00 BSC		
D1	5.25 BSC		
E1	3.75 BSC		
DE	0.375 BSC		
SE	0.375 BSC		
e	0.75 BSC		

Ref	Tolerance of, from and position
aaa	0.10
bbb	0.10
ddd	0.10
eee	0.15
fff	0.08

1. Dimensions in Millimeters.
2. The 'e' represents the basic solder ball grid pitch.
- ③ 'b' is measurable at the maximum solder ball diameter in a plane parallel to datum C.
- ④ Dimension 'ddd' is measured parallel to primary datum C.
- ⑤ Primary datum C (seating plane) is defined by the crowns of the solder balls.
6. Package dimensions refer to JEDEC MO-205 Rev. G.

## Architecture

AS3xxx308 is a high performance MRAM device. Writing to and reading from the device are performed as follows:

To write to the device, bring Chip Enable (E#) and Write Enable (W#) inputs Low (Logic '0'). This enables data on I/O pins (DQ[0] to DQ[7]) to be written into the memory location specified by the address pins (ADDR[0] through ADDR[20] on the 44-pin TSOP and through ADDR[21] on the 48-ball FBGA).

To read from the device, bring Chip Enable (E#) input Low (Logic '0'), Output Enable (G#) input Low (Logic '0') while maintaining Write Enable (W#) High (Logic '1'). This enables data from the memory location specified by the address pins (ADDR[0] through ADDR[20] on the 44-pin TSOP and ADDR[21] on the 48-ball FBGA) to appear on I/O pins (DQ[0] to DQ[7]).

**Figure 3: Functional Block Diagram**

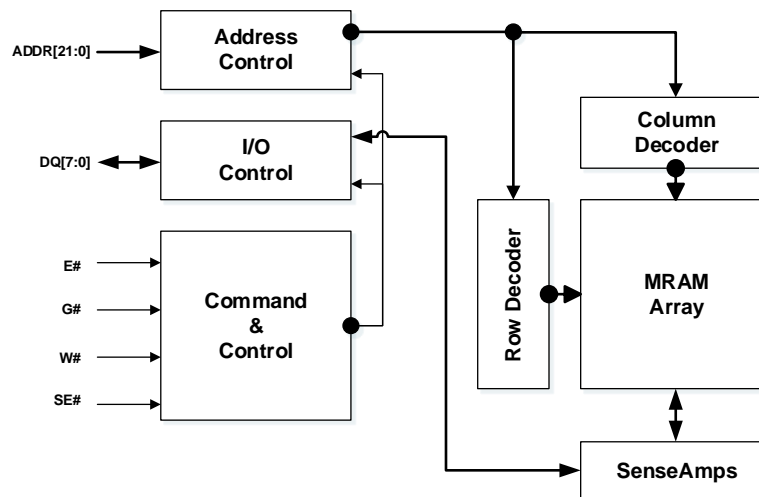

**Table 4: Modes of Operation**

Mode	E#	G#	W#	SE#	Current	DQ[7:0]
<b>Not Selected</b>	H	X	X	H	I <sub>SB</sub>	Hi-Z
<b>Output Disabled</b>	L	H	H	H	I <sub>READ</sub>	Hi-Z
<b>Read</b>	L	L	H	H	I <sub>READ</sub>	Dataout
<b>Write</b>	L	X	L	H	I <sub>WRITE</sub>	Datoin
<b>Sleep</b>	H	X	X	L	I <sub>SLP</sub>	Hi-Z

**Notes:**

H: High (Logic '1')

L: Low (Logic '0')

X: Don't Care

Hi-Z: High Impedance

## Device Initialization

When powering up, the following procedure is required to initialize the device correctly:

- E#, W#, G#, SE# must follow  $V_{CC}$  during power-up

**Figure 4: Power-Up Behavior**

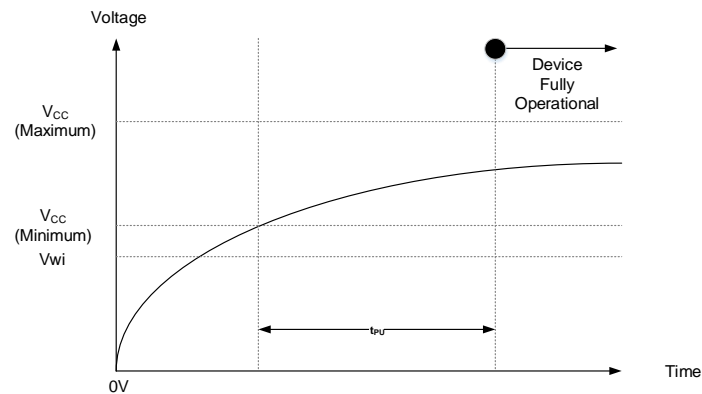

When powering down, the following procedure is required to turn off the device correctly:

- E#, W#, G#, SE# must follow  $V_{CC}$  during power-down
- During power loss or brownout, where  $V_{CC}$  goes below  $V_{wi}$ , read/write operations are prohibited. The power-up timing needs to be observed after  $V_{CC}$  goes above  $V_{CC}$  (minimum)

**Figure 5: Power-Down Behavior**

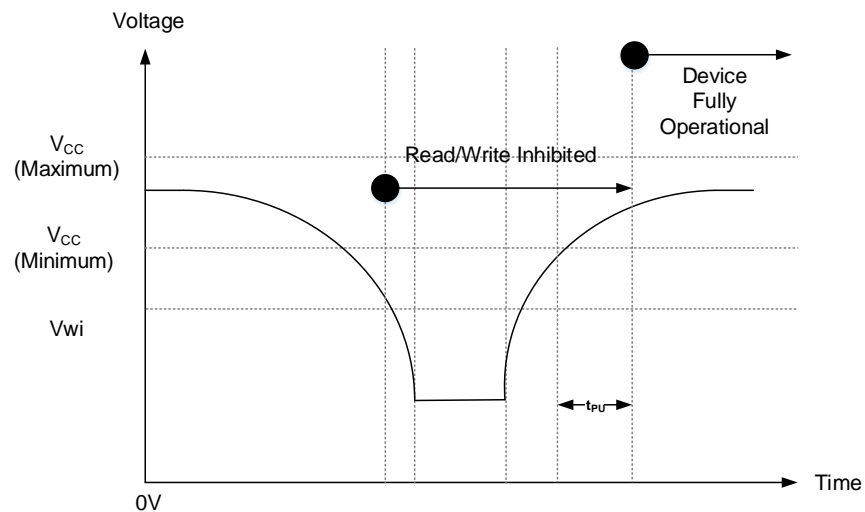

**Sleep Mode** - The device incorporate a sleep mode of operation to achieve lowest power supply current condition

- The device enters the sleep mode by asserting the SE# pin low. Read and Write operation must be completed before the SE# pin going low.
- When SE# is asserted low, it should remain low for at least 5 $\mu$ S.
- Sleep exit is achieved by asserting the SE# pin high. There is a 5 $\mu$ S wait delay before the device is operational.
- If sleep mode is not used, the SE# pin should be tied to  $V_{CC}$ .
  - For existing designs migrating to this device, it is not required to tie this pin to  $V_{CC}$ . The pin can be left as NC. The pin has a pull-up on-chip and the device will function normally with this pin not connected.

**Figure 6: Sleep Mode Timing**

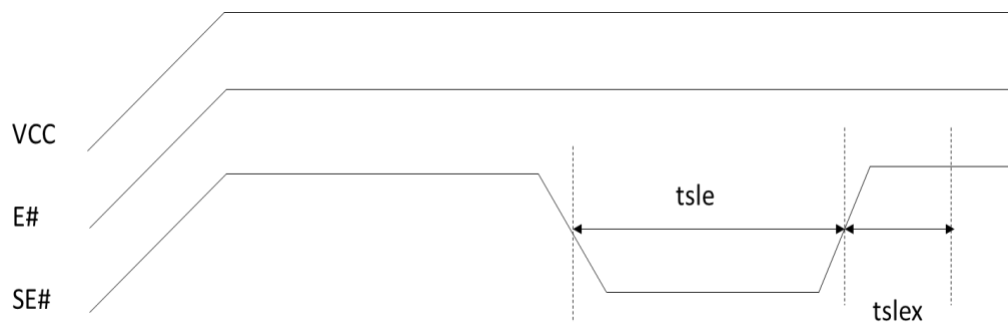

**Table 5: Sleep Mode Timing**

Parameter	Symbol	Minimum	Maximum	Units
<b>Sleep Mode Entry Time</b>	$t_{sle}$	5	-	$\mu$ S
<b>Sleep Mode Exit Time</b>	$t_{slex}$	5	-	$\mu$ S

**Table 6: Device Initialization Timing – 3.0V**

Parameter	Symbol	Test Conditions	3.0V			Units
			Minimum	Typical	Maximum	
<b>V<sub>CC</sub> Range</b>		All operating voltages and temperatures	2.7	-	3.6	V
<b>V<sub>CC</sub> Power Up to First Instruction</b>	t <sub>PU</sub>	All operating voltages and temperatures	-	-	1	ms

## Electrical Specifications

**Table 7: Recommended Operating Conditions**

Parameter / Condition	Minimum	Typical	Maximum	Units	
	Industrial	-40.0	-	85.0	°C
	Industrial Plus	-40.0	-	105.0	°C
V <sub>CC</sub> Supply Voltage	3.0V	2.7	3.0	3.6	V
V <sub>SS</sub> Supply Voltage		0.0	0.0	0.0	V
V <sub>wi</sub> Write Inhibit Voltage		2.1	2.3	2.5	V

**Table 8: Pin Capacitance**

Parameter	Test Conditions	Symbol	Maximum	Units
Input Pin Capacitance	TEMP = 25°C; f = 1 MHz; V <sub>IN</sub> = 0V	C <sub>IN</sub>	10.0	pF
Input / Output Pin Capacitance	TEMP = 25°C; f = 1 MHz; V <sub>IN</sub> = 0V	C <sub>INOUT</sub>	10.0	pF

**Table 9: DC Characteristics**

Parameter	Symbol	Test Conditions	3.0V Device (2.7V-3.6V)			Units	
			Minimum	Typical	Maximum		
Read Current	I <sub>READ</sub>	V <sub>CC</sub> (max), I <sub>OUT</sub> =0mA	-	20.0	30.0	mA	
Write Current	I <sub>WRITE</sub>	V <sub>CC</sub> (max)	-	20.0	30.0	mA	
Standby Current Industrial (-40°C to 85°C)	I <sub>SB</sub>	E#=V <sub>IH</sub> , V <sub>CC</sub> (max)	1Mb-16Mb	-	1.5	1.7	mA
			32Mb	-	3.0	3.4	
Standby Current Industrial Extended (-40°C to 105°C)	I <sub>SB</sub>	E#=V <sub>IH</sub> , V <sub>CC</sub> (max)	1Mb-16Mb	-	1.7	2.0	mA
			32Mb	-	3.4	4.0	
Sleep Mode Current	I <sub>SLP</sub>	V <sub>CC</sub> (max), 85°C	1Mb-16Mb	-	5.0	8.0	uA
			32Mb	-	10.0	16.0	
Input Leakage Current	I <sub>LI</sub>	V <sub>IN</sub> =0 to V <sub>CC</sub> (max)	-	-	±1.0	µA	
Output Leakage Current	I <sub>LO</sub>	V <sub>OUT</sub> =0 to V <sub>CC</sub> (max)	-	-	±1.0	µA	
Input High Voltage	V <sub>IH</sub>		0.8xV <sub>CC</sub>	-	V <sub>CC</sub> +0.3	V	
Input Low Voltage	V <sub>IL</sub>		-0.5	-	0.2xV <sub>CC</sub>	V	
Output High Voltage Level	V <sub>OH</sub>	I <sub>OH</sub> = -1.6mA	V <sub>CC</sub> -0.5	-	-	V	
Output Low Voltage Level	V <sub>OL</sub>	I <sub>OL</sub> = 1.6mA	-	-	0.4	V	

**Table 10: Magnetic Immunity Characteristics**

Parameter	Symbol	Maximum	Units
Magnetic Field During Write	$H_{\max\_write}$	24000	A/m
Magnetic Field During Read	$H_{\max\_read}$	24000	A/m

**Table 11: AC Test Conditions**

Parameter	Value
Input pulse levels	0.0V to $V_{CC}$
Input rise and fall times	5ns
Input and output measurement timing levels	$V_{CC}/2$
Output Load	CL = 30pF



## Write Operation

Figure 7: Write Operation

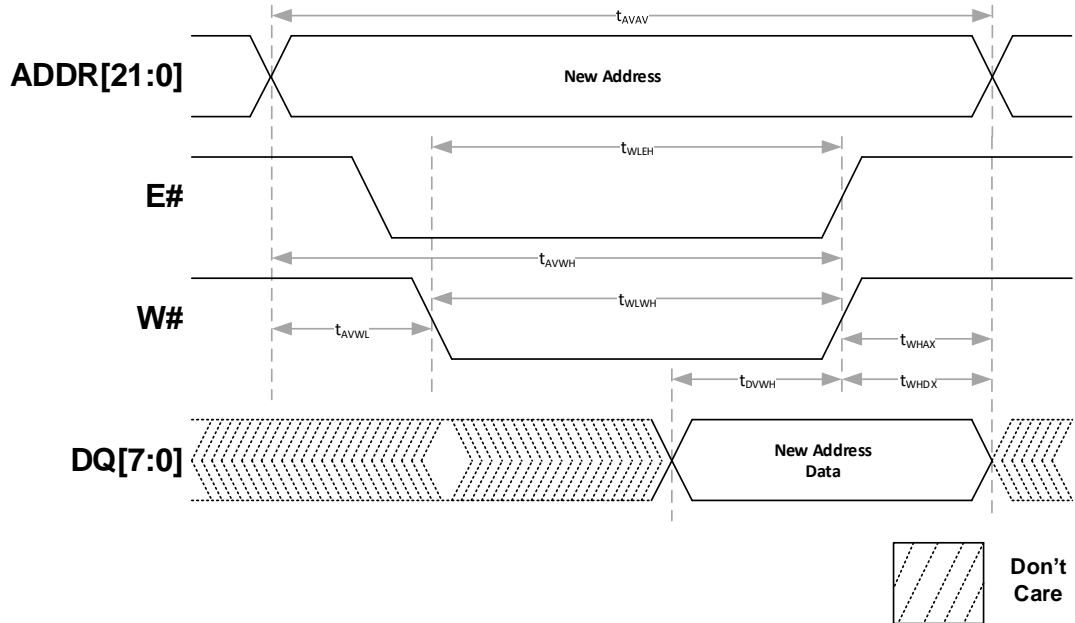

Table 12: Write Operation

Parameter	Symbol	Minimum		Maximum	Units
		35ns	45ns		
Write Cycle Time	$t_{AVAV}$	35	45	-	ns
Address Set-Up Time	$t_{AVWL}$	0		-	ns
Address Valid to end of Write (G# High)	$t_{AVWH}$	18	28	-	ns
Address Valid to end of Write (G# Low)	$t_{AVWH}$	20	30	-	ns
Write Pulse Width (G# High)	$t_{WLWH}, t_{WLEH}$	15	25	-	ns
Write Pulse Width (G# Low)	$t_{WLWH}, t_{WLEH}$	15	25	-	ns
Data Valid to end of Write	$t_{DVWH}$	10	15	-	ns
Data Hold Time	$t_{WHDX}$	0		-	ns
Write recovery Time	$t_{WHAX}$	12		-	ns

**Notes:**

G# is High (Logic '1') for Write operation

Power supplies must be stable

Addresses valid either before or at the same time as E# goes low

Figure 8: Write Operation (E# Controlled)

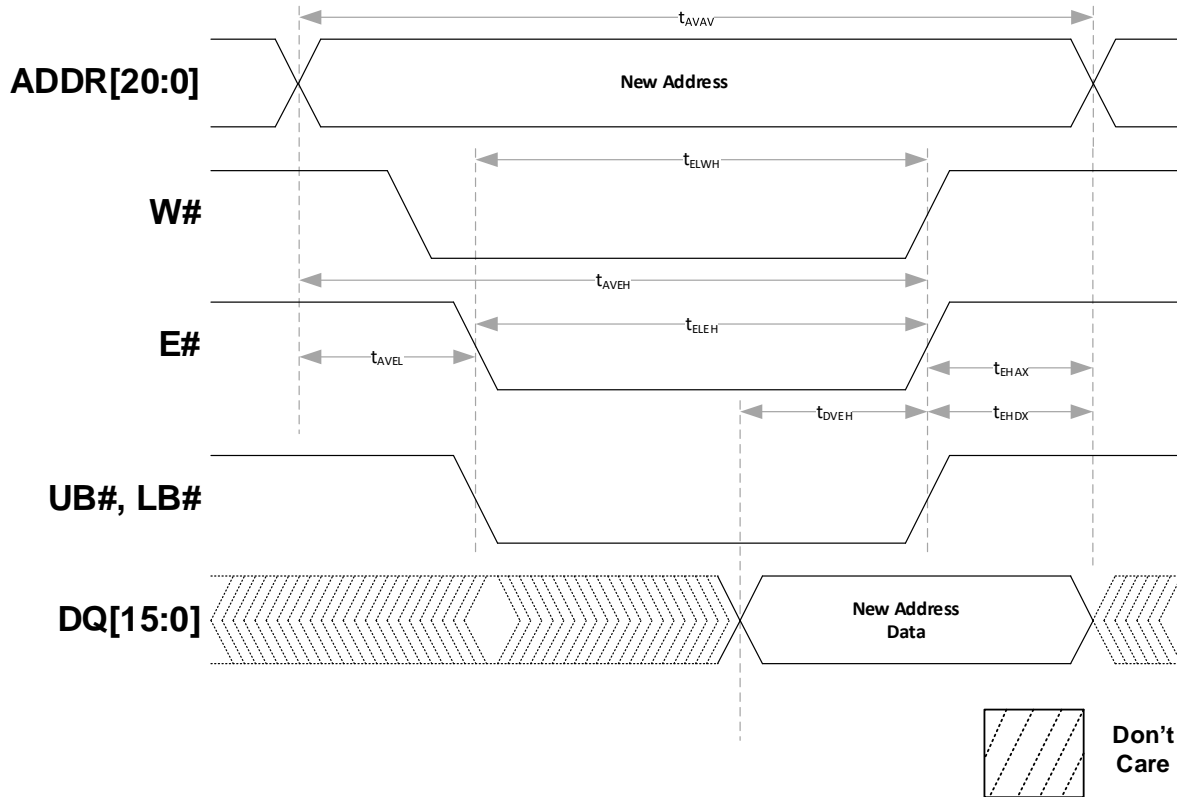

Table 13: Write Operation (E# Controlled)

Parameter	Symbol	Minimum		Maximum	Units
		35ns	45ns		
Write Cycle Time	$t_{AVAV}$	35	45	-	ns
Address Set-Up Time	$t_{AVEL}$	0		-	ns
Address Valid to end of Write (G# High)	$t_{AVEH}$	18	28	-	ns
Address Valid to end of Write (G# Low)	$t_{AVEH}$	20	30	-	ns
Write Pulse Width (G# High)	$t_{ELWH}, t_{ELEH}$	15	25	-	ns
Write Pulse Width (G# Low)	$t_{ELWH}, t_{ELEH}$	15	25	-	ns
Data Valid to end of Write	$t_{DVEH}$	10	15	-	ns
Data Hold Time	$t_{EHDX}$	0		-	ns
Write recovery Time	$t_{EHAX}$	12		-	ns

**Notes:**

G# is High (Logic '1') for Write operation

Power supplies must be stable

Addresses valid either before or at the same time as W# goes low

## Bus Turnaround Operation – Read to Write

Figure 8: Bus Turnaround Operation

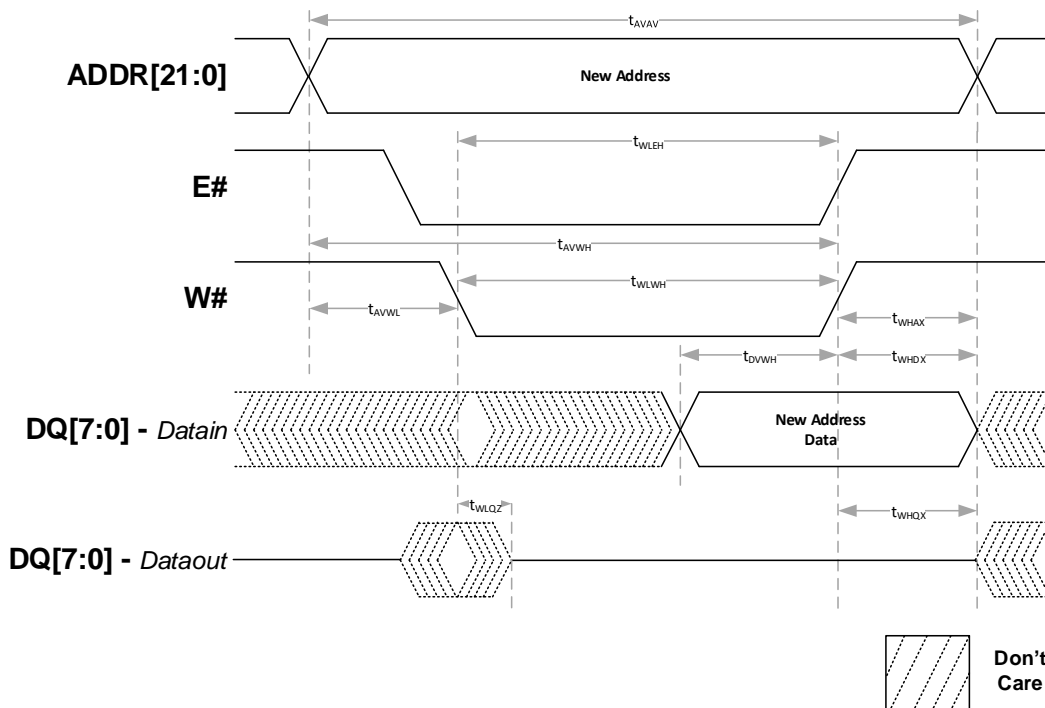

Table 14: Write Operation

Parameter	Symbol	Minimum	Maximum		Units
			35ns	45ns	
W# Low to Data Hi-Z	$t_{WLQZ}$	0	12	15	ns
W# High to Output Active	$t_{WHQX}$	3	-	-	ns

**Notes:**

Power supplies must be stable

Addresses valid either before or at the same time as E# goes low

## Read Operation

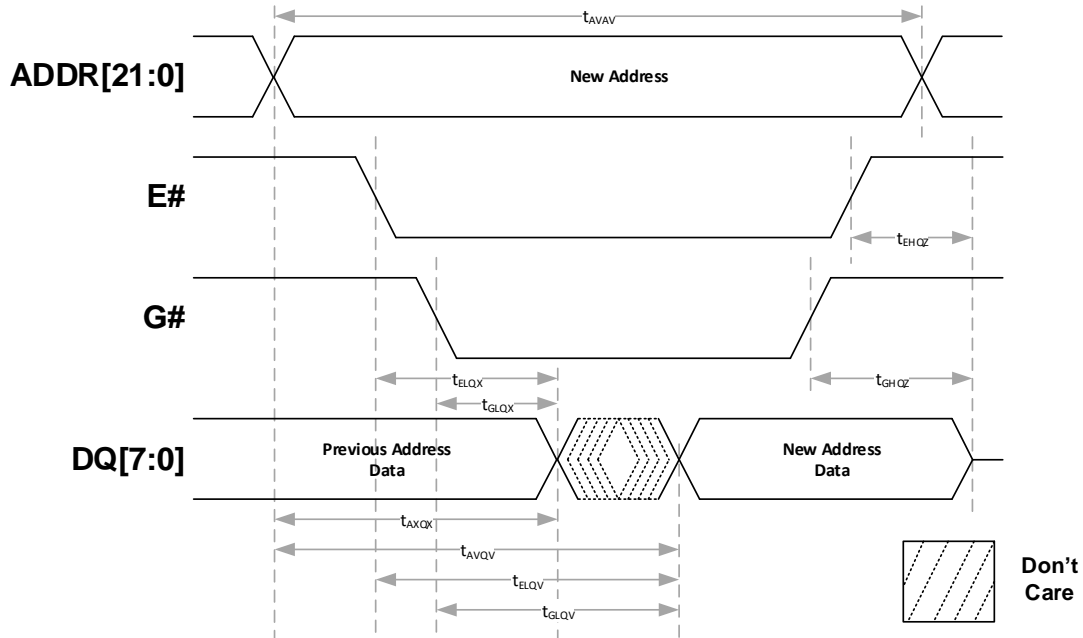
**Figure 9: Read Operation**

**Table 15: Read Operation**

Parameter	Symbol	Minimum		Maximum		Units
		35ns	45ns	35ns	45ns	
Read Cycle Time	$t_{AVAV}$	35	45	-	-	ns
Address Cycle Time	$t_{AVQV}$	-	-	35	45	ns
Chip Enable Access Time	$t_{ELQV}$	-	-	35	45	ns
Output Enable Access Time	$t_{GLQV}$	-	-	15	25	ns
Byte Enable Access Time	$t_{BLQV}$	-	-	15	25	ns
Output Hold From Address Change	$t_{AXQX}$	3	-	-	-	ns
Chip Enable Low to Output Active	$t_{ELQX}$	3	-	-	-	ns
Output Enable Low to Output Active	$t_{GLQX}$	0	-	-	-	ns
Byte Enable Low to Output Active	$t_{BLQX}$	0	-	-	-	ns
Chip Enable High to Output Hi-Z	$t_{EHQZ}$	0	-	15	-	ns
Output Enable High to Output Hi-Z	$t_{GHQZ}$	0	-	10	15	ns
Byte Enable High to Output Hi-Z	$t_{BHQZ}$	0	-	10	-	ns

**Notes:**

W# is High (Logic '1') for Read operation

Power supplies must be stable

Addresses valid either before or at the same time as E# goes low

## Endurance and Data Retention

*Table 16: Endurance & Data Retention*

Parameter	Symbol	Test Conditions	Minimum	Units
<b>Write Endurance</b>	END	-	10 <sup>14</sup>	cycles
<b>Data Retention</b>	RET	105°C	10	years
		85°C	1,000	
		75°C	10,000	
		65°C	1,000,000	

## Thermal Resistance

**Table 17: Thermal Resistance**

Parameter	Description	Test Conditions	44-pin TSOP	48 Ball FBGA (1-16Mb)	48 Ball FBGA (32Mb)	Unit
$\theta_{JA}$	Thermal resistance (junction to ambient)	Test conditions follow standard test methods and procedures for measuring thermal impedance, per EIA/JESD51	40.05	42.67	43.98	°C/W
$\theta_{JC}$	Thermal resistance (junction to case)		7.02	11.09	11.82	

**Notes:**

1: These parameters are guaranteed by characterization; not tested in production.

## Product Use Limitations

Avalanche reserves the right to make changes to the information in this document, and related hardware, software and system (collectively referred to as “**Products**”) without notice. This document supersedes and replaces any and all prior or contemporaneous information or arrangement of any kind relating to the subject matter hereof. This document and any information set forth herein may not be reproduced without the prior written permission from Avalanche.

**Critical Applications.** Products are not authorized for use in applications in which failure of the Avalanche component could result, directly or indirectly in death, personal injury, or severe property or environmental damage (“**Critical Applications**”). Avalanche assumes no liability for Products if used for Critical Applications. Should customer or distributor purchase, use, or sell any Avalanche component for Critical Applications, customer and distributor shall indemnify and hold harmless Avalanche and its subsidiaries, subcontractors, and affiliates and the directors, officers, and employees of each against all claims, costs, damages, and expenses and reasonable attorneys' fees arising out of, directly or indirectly, any claim of product liability, personal injury, or death arising in any way out of such Critical Application, whether or not Avalanche or its subsidiaries, subcontractors, or affiliates were negligent in the design, manufacture, or warning of the Products.

**Automotive Applications.** Products are not authorized for use in automotive applications unless specified by Avalanche. Avalanche assumes no liability for Products if used for automotive applications. Distributor and customer shall assume the sole risk and liability for such use and shall indemnify and hold Avalanche harmless against all claims, costs, damages, and expenses and reasonable attorneys' fees arising out of, directly or indirectly, any claim of product liability, personal injury, death, or property damage resulting directly or indirectly from any use of Products in automotive applications.

**Military Applications.** Products are not rated for use in military applications, including without limitation, for the design, development, use, stockpiling or manufacturing of nuclear, chemical, or biological weapons or missile technology products (mass destruction weapons).

**Customer Responsibility.** Customers are solely responsible for the design and operation of their systems using Products. It is customer's sole responsibility to determine whether Products are suited for their system. Customers are required to incorporate good safety design measures and adequate safeguards to eliminate risks of personal injury, death, or severe property or environmental damages that could result from failure of Products. **AVALANCHE ASSUMES NO LIABILITY FOR CUSTOMERS' PRODUCT DESIGN OR APPLICATIONS AND DAMAGES OR LOSSES OCCURRING AS A RESULT OF NONCOMPLIANCE WITH APPLICABLE LAWS AND REGULATIONS.**

The information contained herein is presented only as guidance for Product use. Avalanche assumes no responsibility for any infringement of patents or any other intellectual property rights of third parties that may result from the use of Products. No license to any intellectual property right is granted by this document, whether expressed or implied. You may not perform compositional, structural, functional or other analysis of Products, or undertake deconvolution or reverse engineering with respect to Products.

### **Limited Warranty**

In no event shall Avalanche and its representatives be liable for any indirect, incidental, punitive, special or consequential damages (including but not limited to loss of use, revenue or profit), whether or not such damages are based on tort, warranty, breach of contract or other legal theory.

In no event shall Avalanche's aggregate liability for any breach, warranty, indemnity or other obligation or liability arising out of or in connection with the sale of Products or the use of any Products exceed the purchase price of the particular Product(s) or services with respect to which losses or damages are claimed.